



FF-ST4 Series

Type 4 Safety Light Curtains

DESCRIPTION

The FF-ST4 Series is designed for hazardous point-of-operation or access detection in industrial machine safeguarding applications. Its enhanced output stage design provides longer cable length through M12 plugs. The Honeywell patented push-pull type OSSD outputs allow for low impedance at any time, while regular open collector type OSSD outputs have high impedance when OFF. As a result, the M12 limited wire section is no longer a constraint.

ASIC technology provides fast response times compared to the micro-processor technology commonly used for safety light curtains. The FF-ST4 light curtain response times are worst-case response times including the sensor and the output stage, the embedded functions processing such as blanking or muting, and possible OSSD output failure modes. Fast response times contribute to shortened safety distances and reduced overall machine size.

FEATURES

- Type 4 per IEC61496-1/2, SIL2 per IEC61508
- Resolutions: 14 mm, 30 mm, 80 mm
- Protection heights: 200 mm to 1400 mm (14 mm and 18 mm resolution) or 200 mm to 1800 mm (30 mm and 80 mm resolution)
- Scanning ranges: 0 m to 3.5 m (14 mm resolution) or 0.25 mm to 10 m (other resolutions)
- Patented, unique solid state safety OSSD outputs allow longer cable lengths
- Patented, automatic polarity recognition inputs provide easy, last minute configuration
- M12, 5 and 8 pole plugs
- ASIC technology provides fast response times
- Metal housing and reduced window size provide sturdy design
- Optimized overall size with reduced inactive zones
- Different function packages available
- Optional AS-i Safe field module

Some models offer flexible configuration of different mode of operations through the M12, 8 pole plug. The Honeywell patented inputs with automatic polarity recognition reduce the amount of wiring and increase the number of configurations while keeping the advantages of the pre-wired, off-the shelf M12 cord sets.

The sturdy metal housing (including zamak end caps), and a small window that reduces exposure to the environment, allow the FF-ST4 to operate in most harsh duty applications.

Accessories include mounting kits, connectors, power supply, and relay modules.

POTENTIAL APPLICATIONS

- Automotive plant floor industry
- Food and beverage industry
- Handling industry
- Machine tool industry
- Packaging industry
- Paper industry
- Special machines

FF-ST4 Series

SPECIFICATIONS

Characteristic	Parameter
Resolution (min. object detection size)	14 mm, 18 mm, 30 mm, 80 mm
Nominal scanning range	0 m to 3.5 m (for 14 mm resolution); 0.25 m to 10 m (for 18 mm, 30 mm, 80 mm resolutions)
Angle of divergence	max. $\pm 5^\circ$ above 3 m (as per IEC/EN 61496-2)
Emitting light source	infrared, pulsed, 880 nm
Supply voltage	24 Vdc ($\pm 20\%$) for the emitter and the receiver
Power consumption	5 W max. for the emitter, 5 W max. for the receiver
Output type	2 safety solid state outputs, push-pull/PNP type with Normally Open characteristics
Response time	see mounting dimensions drawing
Switching capability	350 mA max. at 24 Vdc
Restart time after power up	>1 s (automatic mode)
Restart time after beam release	80 ms (without EDM), 150 ms (with EDM)
Leakage current	0.25 mA
Load impedance	70 Ohm min., 5 kOhm max.
Voltage drop	<2.3 Vdc
Load turn-on voltage	5 V min. on resistive loads, 7 V min. on inductive loads
Test pulse width/recurrence	2 pulses (width 200 us and 75 us), separated by 300 us, frequency from 3.3 ms to 8 ms (depending on height)
Protections	short-circuits and cross-faults, overloads (0.4 A max./0 Vdc; 0.9 A max./24 Vdc), reversed polarity, micro-cut-off 10 ms (100% voltage breakdown, 10 Hz)
Max. cable length	100 m [328.08 ft] (capacitance: 10 nF)
External contact type	relay contact, or static (solid state) PNP or static (solid state) NPN (automatic recognition - no push-pull output allowed)
Filtering time	20 ms by default, 150 ms on the EDM input
Voltage switching thresholds (high/low)	14.5 Vdc min., 4.5 Vdc (complies with IEC 61131-2, for type 2 sensors)
Input current (high/low)	20 mA; 10 mA at 24 Vdc
Max. voltage	29 Vdc
Housing material	aluminum alloy
End cap material	zamak
Window material	PMMA (Polymethylmethacrylate)

FUNCTION PACKAGES

Model	External Device Monitoring (EDM)	Automatic Restart (AUTO)	Restart Interlock (RES)	Muting (or Bypass)	One or Two Beam Floating Blanking	AS-i Safe
FF-ST4 Basic	-	X	-	-	-	X
FF-ST4 Standard	X	X	X	-	-	-
FF-ST4 Advanced M	X	X	X	X	-	-
FF-ST4 Advanced B	X	X	X	-	X	-

Type 4 Safety Light Curtains

MOUNTING DIMENSIONS (For reference only: mm)

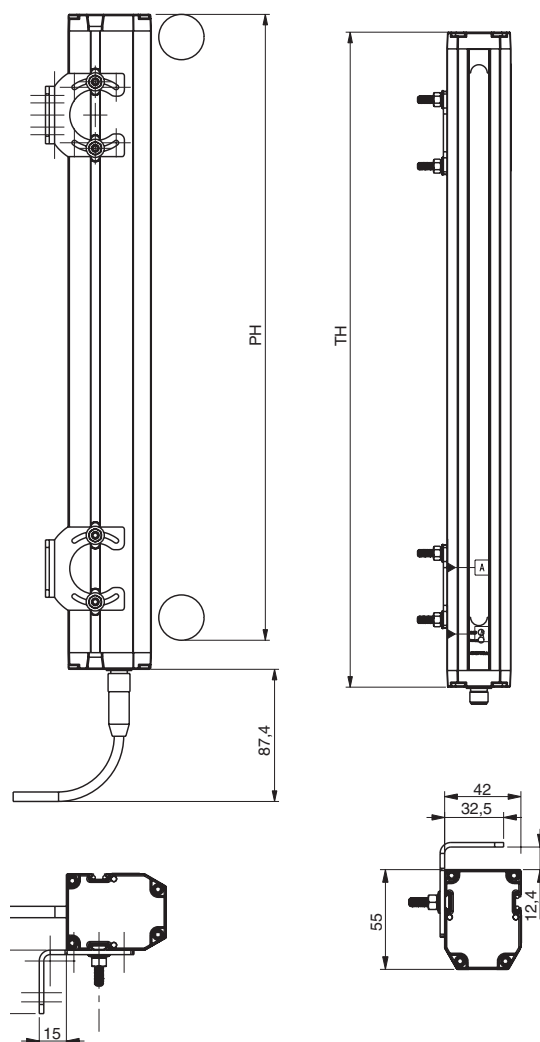

FF-ST4X_XM2	02	03	04	05	06	07	08	09	10	12	14	16	18
Protection Height PH (mm)													
14 mm resolution	206	302	398	494	590	686	782	878	974	1166	1358	NA	NA
18 mm resolution	210	306	402	498	594	690	786	882	978	1170	1362	NA	NA
30 mm, 80 mm resolution	222	318	414	510	606	702	798	894	990	1182	1374	1566	1758
Total Height TH (mm)	242	338	434	530	626	722	818	914	1010	1202	1394	1586	1778
Response Time (ms)*													
14 mm, 18 mm resolution	11	12	12.5	13	14	14.5	15.5	16	16.5	18	19.5	NA	NA
30 mm resolution	11	12	12.5	13	14	14.5	15.5	16	16.5	18	19.5	21	22
80 mm resolution	13.5	14.5	15.5	16	17	18	19	20	21	23	24.5	26.5	28.5

NA: not available

(*) without blanking

FF-ST4 Series

ORDERING INFORMATION

Function package Automatic restart without external device monitoring
 Connection types M12/5 pole on emitter and receiver

FF-ST4 Basic

These on/off sensors are designed for the Honeywell FF-SRL60252 relay module or for the Honeywell FF-SRAC007S AS-i Safe field module.

RECEIVER WIRING DIAGRAM

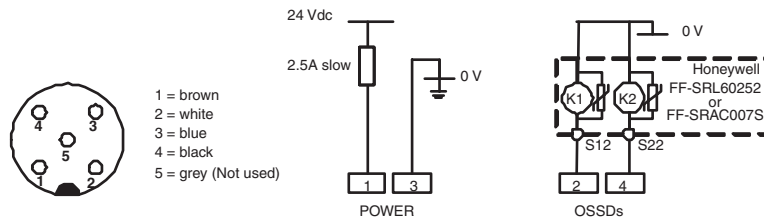

FINGER DETECTION

Resolution 14 mm, Scanning Range 0 m to 3.5 m		Resolution 18 mm, Scanning Range 0.25 m to 10 m	
Protective Height (mm)	Catalog Listing	Protective Height (mm)	Catalog Listing
200	FF-ST4A02AM2	200	FF-ST4B02AM2
300	FF-ST4A03AM2	300	FF-ST4B03AM2
400	FF-ST4A04AM2	400	FF-ST4B04AM2
500	FF-ST4A05AM2	500	FF-ST4B05AM2
600	FF-ST4A06AM2	600	FF-ST4B06AM2
700	FF-ST4A07AM2	700	FF-ST4B07AM2
800	FF-ST4A08AM2	800	FF-ST4B08AM2
1000	FF-ST4A10AM2	1000	FF-ST4B10AM2
1200	FF-ST4A12AM2	1200	FF-ST4B12AM2
1400	FF-ST4A14AM2	1400	FF-ST4B14AM2

HAND, LIMB OR BODY DETECTION

Resolution 30 mm, Scanning Range 0.25 m to 10 m		Resolution 80 mm, Scanning Range 0.25 m to 10 m	
Protective Height (mm)	Catalog Listing	Protective Height (mm)	Catalog Listing
200	FF-ST4C02AM2	200	FF-ST4C02JM2
300	FF-ST4C03AM2	300	FF-ST4C03JM2
400	FF-ST4C04AM2	400	FF-ST4C04JM2
500	FF-ST4C05AM2	500	FF-ST4C05JM2
600	FF-ST4C06AM2	600	FF-ST4C06JM2
700	FF-ST4C07AM2	700	FF-ST4C07JM2
800	FF-ST4C08AM2	800	FF-ST4C08JM2
900	FF-ST4C09AM2	900	FF-ST4C09JM2
1000	FF-ST4C10AM2	1000	FF-ST4C10JM2
1200	FF-ST4C12AM2	1200	FF-ST4C12JM2
1400	FF-ST4C14AM2	1400	FF-ST4C14JM2
1600	FF-ST4C16AM2	1600	FF-ST4C16JM2
1800	FF-ST4C18AM2	1800	FF-ST4C18JM2

Type 4 Safety Light Curtains

ORDERING INFORMATION

FF-ST4 Standard

Function package Selectable automatic or manual restart interlock with external device monitoring
 Connection types M12, 5 pole on emitter and M12, 8 pole on receiver

These on/off sensors are designed to be directly interfaced to the machine final switching devices (e.g. contactors), eliminating the need for a dedicated interface module.

RECEIVER WIRING DIAGRAM

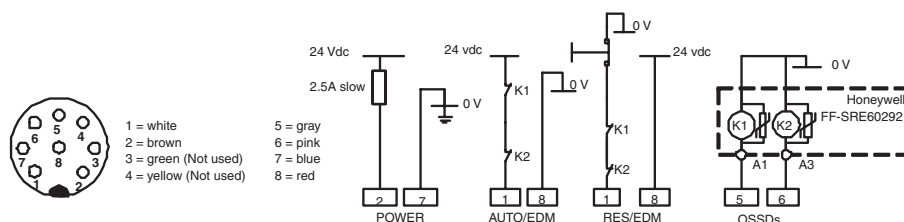

FINGER DETECTION

Resolution 14 mm, Scanning Range 0 m to 3.5 m		Resolution 18 mm, Scanning Range 0.25 m to 10 m	
Protective Height (mm)	Catalog Listing	Protective Height (mm)	Catalog Listing
200	FF-ST4A02DM2	200	FF-ST4B02DM2
300	FF-ST4A03DM2	300	FF-ST4B03DM2
400	FF-ST4A04DM2	400	FF-ST4B04DM2
500	FF-ST4A05DM2	500	FF-ST4B05DM2
600	FF-ST4A06DM2	600	FF-ST4B06DM2
700	FF-ST4A07DM2	700	FF-ST4B07DM2
800	FF-ST4A08DM2	800	FF-ST4B08DM2
1000	FF-ST4A10DM2	1000	FF-ST4B10DM2
1200	FF-ST4A12DM2	1200	FF-ST4B12DM2
1400	FF-ST4A14DM2	1400	FF-ST4B14DM2

HAND, LIMB OR BODY DETECTION

Resolution 30 mm, Scanning Range 0.25 m to 10 m		Resolution 80 mm, Scanning Range 0.25 m to 10 m	
Protective Height (mm)	Catalog Listing	Protective Height (mm)	Catalog Listing
200	FF-ST4C02DM2	200	FF-ST4C02MM2
300	FF-ST4C03DM2	300	FF-ST4C03MM2
400	FF-ST4C04DM2	400	FF-ST4C04MM2
500	FF-ST4C05DM2	500	FF-ST4C05MM2
600	FF-ST4C06DM2	600	FF-ST4C06MM2
700	FF-ST4C07DM2	700	FF-ST4C07MM2
800	FF-ST4C08DM2	800	FF-ST4C08MM2
900	FF-ST4C09DM2	900	FF-ST4C09MM2
1000	FF-ST4C10DM2	1000	FF-ST4C10MM2
1200	FF-ST4C12DM2	1200	FF-ST4C12MM2
1400	FF-ST4C14DM2	1400	FF-ST4C14MM2
1600	FF-ST4C16DM2	1600	FF-ST4C16MM2
1800	FF-ST4C18DM2	1800	FF-ST4C18MM2

FF-ST4 Series

ORDERING INFORMATION

Function package Selectable automatic or manual restart interlock with external device monitoring and muting
 Connection types M12, 5 pole on emitter and M12, 8 pole on receiver

FF-ST4 Advanced M

Muting (or bypass) allows objects to pass through the protection field without stopping the machine. Muting is permitted when personnel are not exposed to the hazard (e.g. manual loading/unloading) or when the hazard cannot be accessed without a stop (e.g. conveyor).

NOTICE

MUTING SENSOR OUTPUT TYPE

The muting sensors can be any device with either relay outputs or solid state output. Devices with solid state push-pull outputs cannot be used.

RECEIVER WIRING DIAGRAM

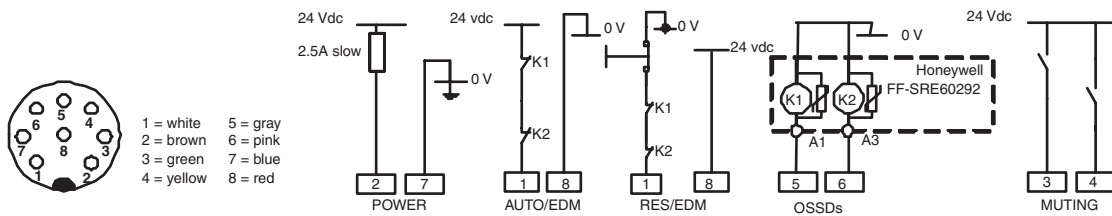

FINGER DETECTION

Resolution 14 mm, Scanning Range 0 m to 3.5 m		Resolution 18 mm, Scanning Range 0.25 m to 10 m	
Protective Height (mm)	Catalog Listing	Protective Height (mm)	Catalog Listing
200	FF-ST4A02VM2	200	FF-ST4B02VM2
300	FF-ST4A03VM2	300	FF-ST4B03VM2
400	FF-ST4A04VM2	400	FF-ST4B04VM2
500	FF-ST4A05VM2	500	FF-ST4B05VM2
600	FF-ST4A06VM2	600	FF-ST4B06VM2
700	FF-ST4A07VM2	700	FF-ST4B07VM2
800	FF-ST4A08VM2	800	FF-ST4B08VM2
1000	FF-ST4A10VM2	1000	FF-ST4B10VM2
1200	FF-ST4A12VM2	1200	FF-ST4B12VM2
1400	FF-ST4A14VM2	1400	FF-ST4B14VM2

HAND, LIMB OR BODY DETECTION

Resolution 30 mm, Scanning Range 0.25 m to 10 m		Resolution 80 mm, Scanning Range 0.25 m to 10 m	
Protective Height (mm)	Catalog Listing	Protective Height (mm)	Catalog Listing
200	FF-ST4C02VM2	200	FF-ST4C02D1M2
300	FF-ST4C03VM2	300	FF-ST4C03D1M2
400	FF-ST4C04VM2	400	FF-ST4C04D1M2
500	FF-ST4C05VM2	500	FF-ST4C05D1M2
600	FF-ST4C06VM2	600	FF-ST4C06D1M2
700	FF-ST4C07VM2	700	FF-ST4C07D1M2
800	FF-ST4C08VM2	800	FF-ST4C08D1M2
900	FF-ST4C09VM2	900	FF-ST4C09D1M2
1000	FF-ST4C10VM2	1000	FF-ST4C10D1M2
1200	FF-ST4C12VM2	1200	FF-ST4C12D1M2
1400	FF-ST4C14VM2	1400	FF-ST4C14D1M2
1600	FF-ST4C16VM2	1600	FF-ST4C16D1M2
1800	FF-ST4C18VM2	1800	FF-ST4C18D1M2

Type 4 Safety Light Curtains

ORDERING INFORMATION

FF-ST4 Advanced B

Function package Selectable automatic or manual restart interlock with external device monitoring and selectable one or two-beam floating blanking

Connection types M12, 5 pole on emitter and M12, 8 pole on receiver

The built-in floating blanking feature provides a means for the random inhibition of one or two light curtain beams. It is useful in applications where material or air-ejected parts randomly travel through or within the sensing field. Light beams may be disabled in an area where a fixture penetrates the light field, and stationary objects may not be allowed to protrude into the light curtain's sensing field. Any beam within the light curtain detection field may be blanked.

⚠ WARNING

INCORRECT SAFETY DISTANCE WHEN USING FLOATING BLANKING

- Floating blanking increases the light curtain resolution and the response time. Therefore, the safety distance between the light curtain and the hazardous area shall be increased.
 - Refer to the installation manual for detailed information on resolution and calculating the safety distance.
- Failure to comply with these instructions could result in death or serious injury.**

RECEIVER WIRING DIAGRAM

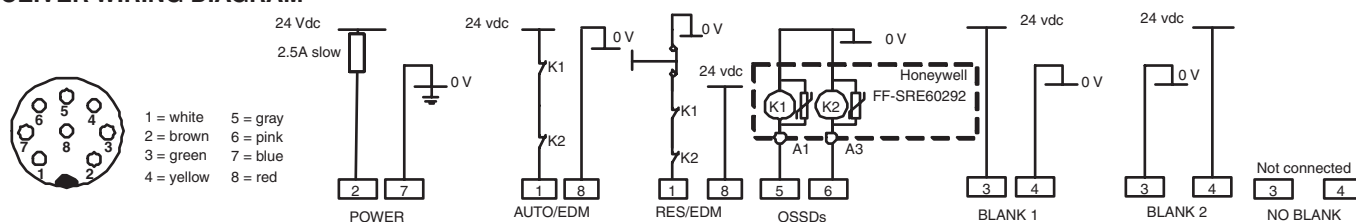

FINGER DETECTION





Resolution 14 mm, Scanning Range 0 m to 3.5 m		Resolution 18 mm, Scanning Range 0.25 m to 10 m	
Protective Height (mm)	Catalog Listing	Protective Height (mm)	Catalog Listing
200	FF-ST4A02RM2	200	FF-ST4B02RM2
300	FF-ST4A03RM2	300	FF-ST4B03RM2
400	FF-ST4A04RM2	400	FF-ST4B04RM2
500	FF-ST4A05RM2	500	FF-ST4B05RM2
600	FF-ST4A06RM2	600	FF-ST4B06RM2
700	FF-ST4A07RM2	700	FF-ST4B07RM2
800	FF-ST4A08RM2	800	FF-ST4B08RM2
1000	FF-ST4A10RM2	1000	FF-ST4B10RM2
1200	FF-ST4A12RM2	1200	FF-ST4B12RM2
1400	FF-ST4A14RM2	1400	FF-ST4B14RM2

HAND, LIMB OR BODY DETECTION

Resolution 30 mm, Scanning Range 0.25 m to 10 m		Resolution 30 mm, Scanning Range 0.25 m to 10 m	
Protective Height (mm)	Catalog Listing	Protective Height (mm)	Catalog Listing
200	FF-ST4C02RM2	900	FF-ST4C09RM2
300	FF-ST4C03RM2	1000	FF-ST4C10RM2
400	FF-ST4C04RM2	1200	FF-ST4C12RM2
500	FF-ST4C05RM2	1400	FF-ST4C14RM2
600	FF-ST4C06RM2	1600	FF-ST4C16RM2
700	FF-ST4C07RM2	1800	FF-ST4C18RM2
800	FF-ST4C08RM2		

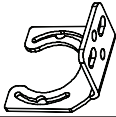

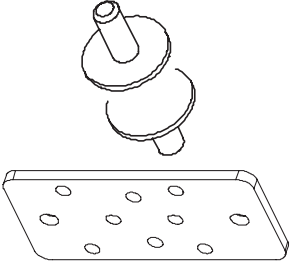

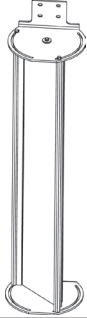
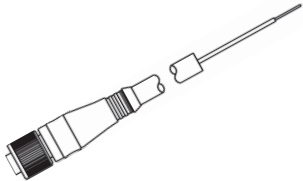
FF-ST4 Series

ACCESSORIES

Catalog Listing	Picture	Description
FF-SGZ001001		Basic mounting kit includes two M5 dovetail shape bolts, two M5 nuts and two rip-lock washers. (These are already included in the FF-ST package.) Order two kits for a complete set to use with emitter and receiver.
FF-SYZ634178		Right angle bracket kit includes two right angle brackets with four sets of M5 bolts, nuts and washers. Order two kits for a complete set to use with emitter and receiver.
FF-SXZ634189		Adjustable bracket kit includes two right angle brackets with four sets of M5 bolts, nuts and washers. Allows adjustments in azimuth directions of $\pm 4^\circ$ with front access of the adjusting screws. Order two kits for a complete set to use with emitter and receiver).
FF-SYZAD		Kit includes two straight brackets and four anti-vibration dampers (mounting hardware included). In case of high vibration applications, order: <ul style="list-style-type: none"> • Two FF-SYZAD kits for light curtain systems with protection heights below 1000 mm. • Three FF-SYZAD kitS for light curtain systems with protection heights greater or equal to 1000 mm, but less than 1800 mm. • Four FF-SYZAD kits for light curtain systems with protection heights equal to 1800 mm.
FF-SYZPF FF-SYZPFM11		Floor standing posts. <ul style="list-style-type: none"> • 1300 mm high beam post. (Order two pieces for a complete light curtain set and two FF-SYZ634178 bracket kits.) • 1170 mm high plain mirror post (25% scanning range reduction). Recommended for light curtains with a protection height of up to 1000 mm.
FF-SYZMIR102 FF-SYZMIR104 FF-SYZMIR106 FF-SYZMIR108 FF-SYZMIR110 FF-SYZMIR112 FF-SYZMIR114 FF-SYZMIR116 FF-SYZMIR118		Wall mount plain mirrors (25% scanning range reduction). Top and bottom brackets included ($\pm 45^\circ$ angle adjustment). Suitable for: <ul style="list-style-type: none"> • FF-ST__02_M2 • FF-ST__03_M2 and FF-ST__04_M2 • FF-ST__05_M2 and FF-ST__06_M2 • FF-ST__07_M2 and FF-ST__08_M2 • FF-ST__09_M2 and FF-ST__10_M2 • FF-ST__12_M2 • FF-ST__14_M2 • FF-ST__16_M2 • FF-ST__18_M2
FF-SXZCAM125U02-S FF-SXZCAM125U05-S FF-SXZCAM125U05-90S FF-SXZCAM125U10-S FF-SXZCAM125U10-90S FF-SXZCAM128U02-S FF-SXZCAM128U05-S FF-SXZCAM128U05-90S FF-SXZCAM128U10-S FF-SXZCAM128U10-90S		M12 single-ended cordsets, female, 5 pin. <ul style="list-style-type: none"> • 2 m, straight • 5 m, straight • 5 m, right angle • 10 m, straight • 10 m, right angle M12 single-ended cordsets, female, 8 pin. <ul style="list-style-type: none"> • 2 m, straight • 5 m, straight • 5 m, right angle • 10 m, straight • 10 m, right angle

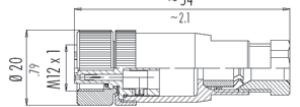
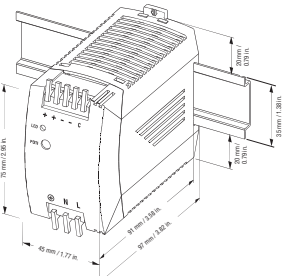
Type 4 Safety Light Curtains

ACCESSORIES (continued)

Catalog Listing	Picture	Description
FF-SXZCOM125 FF-SXZCOM128		M12 screw connector, female, straight, 5 pin M12 screw connector, female, straight, 8 pin
FF-SXZPWR050		ac to dc power supply (ordered separately as an option). <ul style="list-style-type: none"> • UL508 listed, UL1950, cUL/CSA-C22.2 No. 950-M90, EN/IEC 60950, EN 50178 (Class 2 rated for low power installations) • Input voltage: 85 Vac to 264 Vac (43 Hz to 67 Hz) • Output voltage: 24 Vdc to 28 Vdc adjustable • Rated continuous load (at 60 °C [140 °F] max.): 2.1 A at 24 Vdc/ 1.8 A at 28 Vdc • Power: 50 W • Dimensions: 75 mm x 45 mm x 97 mm • DIN rail mounting • Weight: 240 g
FF-SRL60252		Dual channel module for the FF-ST4 Basic models. <ul style="list-style-type: none"> • 22,5 mm width, 3 NO/1 NC internally redundant safety relay outputs (See separate product data sheet for detailed information.)
FF-SRAC007S (input module) FF-SRAC5003 (DIN rail and panel quick mount base for AS-i flat cables)		AS-i Safe input module for the FF-ST4 basic models. <ul style="list-style-type: none"> • Category 4 per EN954-1 and SIL3 per IEC61508 • Connection of the FF-ST4 emitter and receiver via a pair of M12 sockets • An external power supply is required to power the light curtain through the black flat cable. Order the DIN rail and panel quick mount base for AS-i flat cables: FF-SRAC5003 • Maximum cable length between light curtain and module is 10 m • 31 modules per master module • IP 67 protection rating • Dimensions: 110 mm x 45 mm x 70 mm (with the base) • Material: PA 6 (module), PBT (base) • CE approved, UL/CSA (application approval pending) • AS-i details: versions 2.11 and 3.0, profile S-0.B.E
FF-SRE60292 FF-SRE30812		Expansion relay modules for the FF-ST4 Standard A and Standard M models. <ul style="list-style-type: none"> • 22,5 mm width, 4 NO/2 NC safety relay outputs • 90 mm width, 7 NO/1 NC safety relay outputs (See separate product data sheet for detailed information.)
FF-SRL59022		Presence sensing device initiation module (PSDI) for the automatic machine cycle start to be used with light curtains with a resolution less than or equal to 30 m. (See separate product data sheet for detailed information.)



WARNING **MISUSE OF DOCUMENTATION**

- The information presented in this product sheet is for reference only. Do not use this document as a product installation guide.
- Complete installation, operation, and maintenance information is provided in the instructions supplied with each product.

Failure to comply with these instructions could result in death or serious injury.

Warranty/Remedy

Honeywell warrants goods of its manufacture as being free of defective materials and faulty workmanship. Honeywell's standard product warranty applies unless agreed to otherwise by Honeywell in writing; please refer to your order acknowledgement or consult your local sales office for specific warranty details.

Honeywell warrants goods of its manufacture as being free of defective materials and faulty workmanship. If warranted goods are returned to Honeywell during the period of coverage, Honeywell will repair or replace, at its option, without charge those items it finds defective. **The foregoing is buyer's sole remedy and is in lieu of all warranties, expressed or implied, including those of merchantability and fitness for a particular purpose. In no event shall Honeywell be liable for consequential, special, or indirect damages.**

While we provide application assistance personally, through our literature and the Honeywell web site, it is up to the customer to determine the suitability of the product in the application.

Specifications may change without notice. The information we supply is believed to be accurate and reliable as of this printing. However, we assume no responsibility for its use.

Sales and Service

Honeywell serves its customers through a worldwide network of sales offices, representatives and distributors. For application assistance, current specifications, pricing or name of the nearest Authorized Distributor, contact your local sales office or:

E-mail: info.sc@honeywell.com

Internet: www.honeywell.com/sensing

Phone and Fax:

Asia Pacific	+65 6355-2828
	+65 6445-3033 Fax
Europe	+44 (0) 1698 481481
	+44 (0) 1698 481676 Fax
Latin America	+1-305-805-8188
	+1-305-883-8257 Fax
USA/Canada	+1-800-537-6945
	+1-815-235-6847
	+1-815-235-6545 Fax

Sensing and Control
Honeywell
1985 Douglas Drive North
Minneapolis, Minnesota 55422
www.honeywell.com

107160-2-EN FR26 GLO
January 2008
Copyright 2008 Honeywell International Inc. All rights reserved.

Honeywell